

Electric heater D-EWT Neo Compact 1.5 to 18 kW plastic/ incoloy or titanium

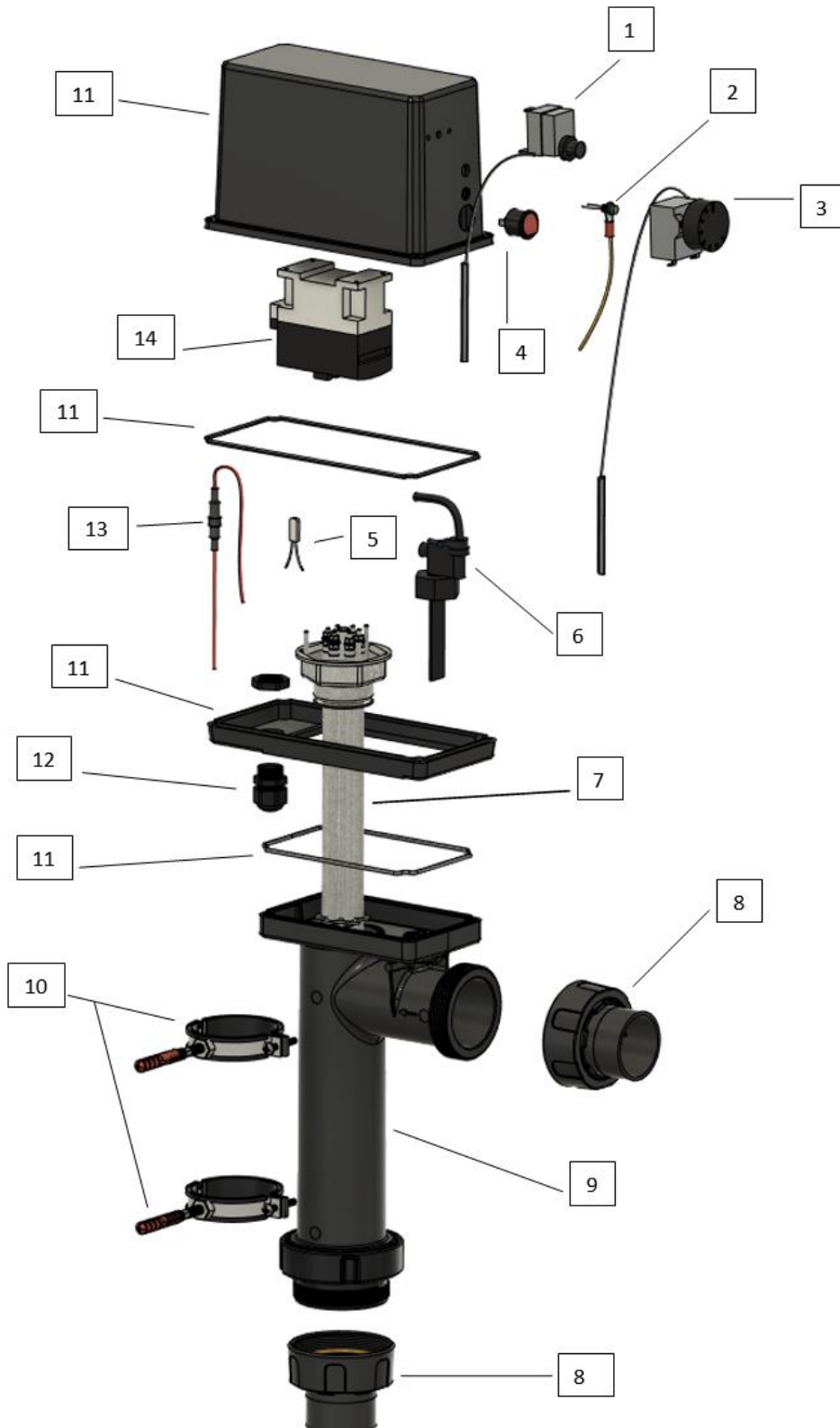

Spare parts

no. Item	no. drawing	material	description of spare part
10 70 00	1	Various	safety thermostat 50°C
10 70 01	2	various	LED 230 V
10 70 02	3	various	Thermostat 0-40 °C
10 70 03	4	various	ON/ OFF Switch
10 70 04	5	various	BI Metall 55 °C (only 12-18 kW)
11 41 05	6	various	Flow switch R1B
10 70 06	7	Incoloy 825	heating element 1,5 kW
10 70 07	7	Incoloy 825	heating element 3 kW
10 70 08	7	Incoloy 825	heating element 6 kW
10 70 09	7	Incoloy 825	heating element 9 kW
10 70 10	7	Incoloy 825	heating element 12 kW
10 70 11	7	Incoloy 825	Heating element 15 kW
10 70 12	7	Incoloy 825	heating element 18 kW
10 70 13	7	Titanium	heating element 3 kW
10 70 14	7	Titanium	heating element 6 kW
10 70 15	7	Titanium	heating element 9 kW
10 70 16	7	Titanium	heating element 12 kW
10 70 17	7	Titanium	heating element 18 kW
10 70 18	8	ABS	gluing socket D.50
10 70 19	9	PP 30% FG.FR	housing 1,5-3 kW
10 70 20	9	PP 30% FG.FR	housing 6-9 kW
10 70 21	9	PP 30% FG.FR	housing 12-15 kW
10 70 22	9	PP 30% FG.FR	housing 18 kW
10 70 23	10	various	Clamp 66-72 mm(single)
10 70 24	11	ABS	Electric housing
10 70 25	12	Polyamid	cable gland 1,5- 6 kW
10 70 26	12	Polyamid	cable gland 9-12 kW
10 70 27	12	Polyamid	cable gland 12- 15 kW
10 70 28	12	Polyamid	cable gland M32
10 70 28	13	various	fuse holder
11 41 81	14	various	Connector 1,5 – 9 kW
11 19 07	14	Various	Connector 12- 15 kW
11 41 53	14	various	Connector 18 kW